

# LWPRO-675-1

Professional 675nm red IP67 waterproof 1mW laser module



## Description

The LWPRO-675-1 is a professional low-power semiconductor red laser module that provides stable continuous light output of 1mW at an emission wavelength of 675nm. The product includes a high-performance APC switched-mode laser diode driver, enabling operation over a wide range of

input voltages. The fully sealed IP67-rated stainless steel housing allows this laser module to be used in harsh environments, especially in high dust and humidity. The all-glass optics allow for a high quality laser beam, compared to lasers with acrylic optics.

## Applications

- Cutting line indicator for stone masonry, woodworking, carpentry and other material processing
- Industrial positioning, alignment and inspection on assembly lines
- 3D scanning, shape mapping and object detection
- Laboratory equipment, biomedical applications, metrology and spectral sensing
- Night vision illumination, illumination for infrared cameras and astronomy
- Display systems, stage lighting, laser projection and laser shows
- Other applications

## WARNING

**DO NOT CONNECT THIS LASER DIRECTLY TO 120VAC MAINS, 230VAC MAINS OR ANY OTHER HIGH VOLTAGE!**

This laser component is powered by low DC voltage with the value specified below in this document. Connecting this unit to voltages higher than those specified in the Absolute maximum ratings section, especially to mains voltage or any other unstabilized AC or DC high voltage, will immediately damage the laser internal electronics and may expose you to deadly danger to your health or even life. In addition, any case in which we find that the laser has been connected to a voltage higher than that specified in the Absolute maximum ratings section, whether we detect this by seeing the completely burned electronics inside, or by checking the highest connected supply voltage stored in the Flash memory of the built-in microcontroller, will void the warranty.

## Features

- Fully waterproof and dustproof IP67-rated housing made of corrosion-resistant stainless steel
- Small size and compact design
- Integrated high efficiency APC switched-mode laser diode driver
- Reputable manufacturer single-mode semiconductor laser diode
- Wide input voltage range
- Wide operating temperature range
- Integrated overvoltage, overtemperature, reverse polarity and ESD protection
- Case connected to negative terminal

## Output optics variants

- -DOT - standard point optics
- -RLINE - standard line optics - glass rod line lens - line divergence angle about 60° FWHM, total line angle more than 100°
- -Pxx - uniform brightness line optics - glass Powell line lens - 15°, 30°, 45°, 60°, 75° or 90°
- -SCROSS - cross optics - glass sinusoidal cross lens - divergence angle about 110°
- -DOExx - pattern optics - DOE diffractive optical elements - various patterns available

## Available accessories

- M8, M5 or M12 power cables in 2m, 5m, 10m or 20m lengths

- Industrial mounts mounted to either plane or V-slot profiles, with optional tilt and rotary joints
- Industry mounts mounted to a rod, with optional rotary joints
- Laboratory mounts mounted to an optical table, with adjustable laser position in multiple planes
- Non-laser blocking goggles, for working in very bright conditions or when illuminating objects that emit light themselves
- Safety glasses for working with high-power lasers

## Customizations

This laser module can be fully customized to customer requirements. Sample adjustments may include:

- Different output power - from less than 1mW, to more than 5000mW
- Different color and wavelength - for example 375nm, 395nm, 405nm, 425nm, 450nm, 462nm, 473nm, 488nm, 505nm, 520nm, 638nm, 660nm, 675nm, 690nm, 705nm, 730nm, 785nm, 808nm, 830nm, 850nm, 905nm, 940nm, 980nm
- TTL digital modulating input, high-speed analog input 0-5V, laser power controllable by 0-5V, 4-20mA signal or 10k potentiometer, laser monitoring output, laser control via RS485
- Different types of output optics and various options for setting the working distance
- Different size and shape of housing, different types of power connectors
- Brand marking for OEM customers

## Overview diagram of the laser module

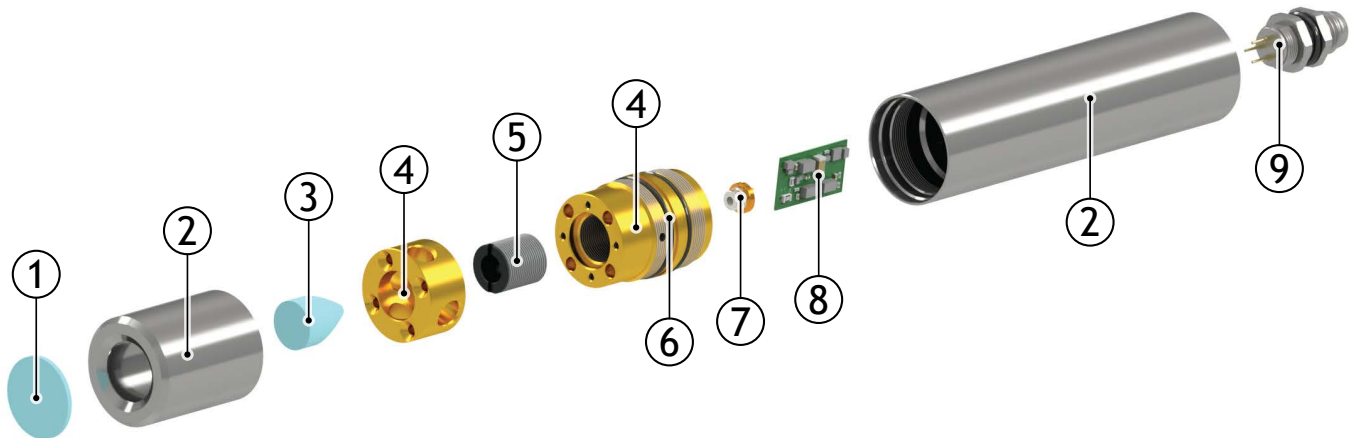

1. Output window made of high-quality optical glass with double-sided AR coating
2. Housing resistant to harsh conditions made of stainless steel or aluminum
3. Line or cross optics made of high quality optical glass
4. Mounting of optics and laser diode with excellent thermal conductivity and high temperature stability made of brass
5. High quality three-element collimator made of optical glass with AR coatings
6. Rubber O-rings on every connection for complete waterproof and dustproof protection
7. High-quality laser diode from a reputable manufacturer
8. High efficiency laser diode driver designed and manufactured by LAMBDAWAVE
9. Waterproof and dustproof M8, M12 or other power connector

## Naming convention

LWPRO - 675 - 1 - RLINE - F2000-TTL

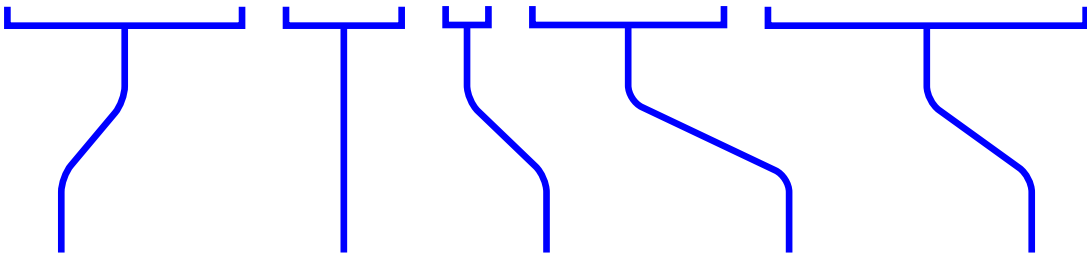

Product family	Wavelength	Power	Optics type	Extra options (optional field)
LWPRO	375	1	DOT	
LWPRO12	395	2	RLINE	M8/3P
LWPRO40	405	5	P15	M12/4P
LWPRO40-BL	425	10	P30	Fxxxx
LWPRO20-EA	450	20	P45	NOLOCK
LWPRO22	462	50	P60	M18x1
LWPRO26	473	100	P75	DC55/21
Customized	488	200	P90	DC55/25
	505	500	SCROSS	M8GL/xM
	520	1000	DOExx	TTL
	638	2000	Customized	PD
	660	5000		5V
	675	Other		HSAMOD
	690			PC05V
	705			PC420MA
	730			PC10K
	785			MM
	808			FBPNPNO
	830			FBPNPNO
	850			RS485
	905			Customized
	940			
	980			
	Other			

## Recommended operating conditions

Proper operation of the device is not guaranteed beyond the Recommended operating conditions. Exceeding the values below, as long as the laser is powered, will cause the value of the exceeded parameter to be stored in the internal Flash memory of the built-in microcontroller.

Parameter	Min.	Typ.	Max.	Unit
Supply voltage	4.5	-	26.0	V DC
Operating temperature	-10	-	50	°C

## Absolute maximum ratings

Exceeding the maximum voltage values will permanently damage the device. Exceeding other Absolute maximum ratings may damage the device. Exceeding the values below, as long as the laser is powered, will cause the value of the exceeded parameter to be stored in the internal Flash memory of the built-in microcontroller and will void the warranty.

Parameter	Min.	Typ.	Max.	Unit
Supply voltage	-	-	28.0	V DC
Operating temperature	-20	-	60	°C
Storage temperature	-40	-	85	°C

## Electrical characteristics

Parameter	Min.	Typ.	Max.	Unit
Supply voltage	4.5	-	26.0	V DC
Input current at $V_{IN}=4.5V$	-	TBD	-	mA
Input current at $V_{IN}=26.0V$	-	TBD	-	mA
Input UVLO threshold - $V_{IN}$ rising	-	4.35	-	V
Input UVLO threshold - $V_{IN}$ falling	-	4.10	-	V
Input UVLO hysteresis	-	0.25	-	V
Input OVLO threshold - $V_{IN}$ rising	-	27.5	-	V
Input OVLO threshold - $V_{IN}$ falling	-	27.0	-	V
Input OVLO hysteresis	-	0.50	-	V

## Optical characteristics

Parameter	Min.	Typ.	Max.	Unit
Peak wavelength	670	675	680	nm
Laser diode output power	0.85	1.00	1.15	mW
Collimating lens power loss	-	23.0	-	%
Output power behind collimating lens	0.63	0.77	0.94	mW
Collimating lens EFL	-	8.36	-	mm
Theoretical FWHM beam dimensions at output	-	1.17 * 2.2	-	mm * mm
Collimating lens CA clear aperture	-	5.00	-	mm
Collimating lens NA numerical aperture	-	0.24	-	-
Collimated beam divergence	-	<0.5 * <0.5	-	mrاد * mrاد
Output power temperature coefficient	-0.05	-	0.05	%/°C
Wavelength temperature coefficient	-	0.182	-	nm/°C

Unless otherwise noted, all optical parameters are given for T=25°C

## Other specifications

Parameter	Min.	Typ.	Max.	Unit
Softstart time after power-on event	-	1000	-	ms
Softstart time after UVLO or OVLO event	-	500	-	ms
Minimum off time after UVLO or OVLO event	-	2000	-	ms
Lifetime	20000	-	-	h

## Typical performance curves

LWPRO-675-1

Input current vs. input voltage

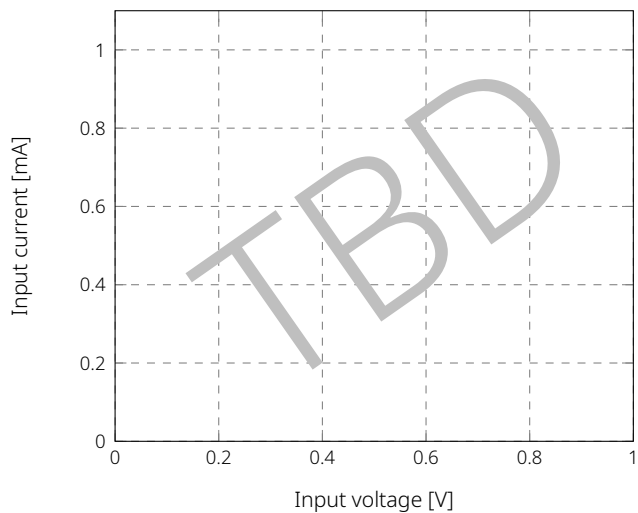

LWPRO-675-1

Relative output power vs. temperature

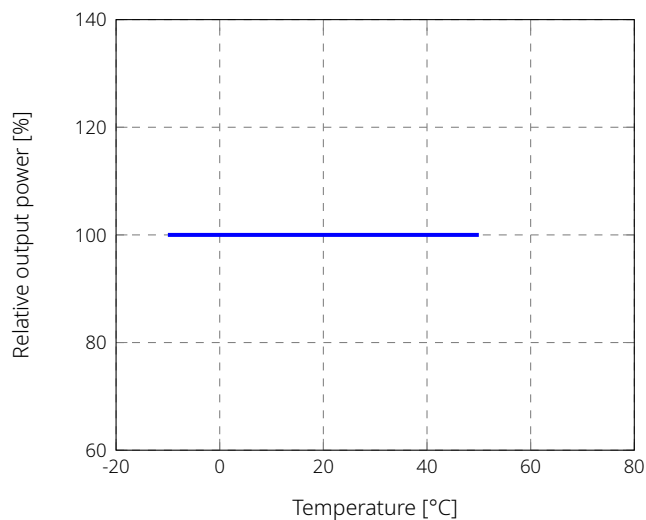

LWPRO-675-1

Relative output power vs. input voltage

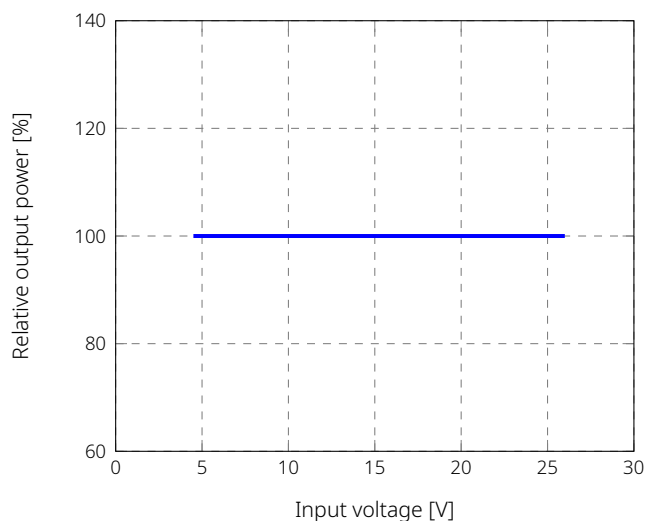

LWPRO-675-1

Wavelength shift vs. temperature

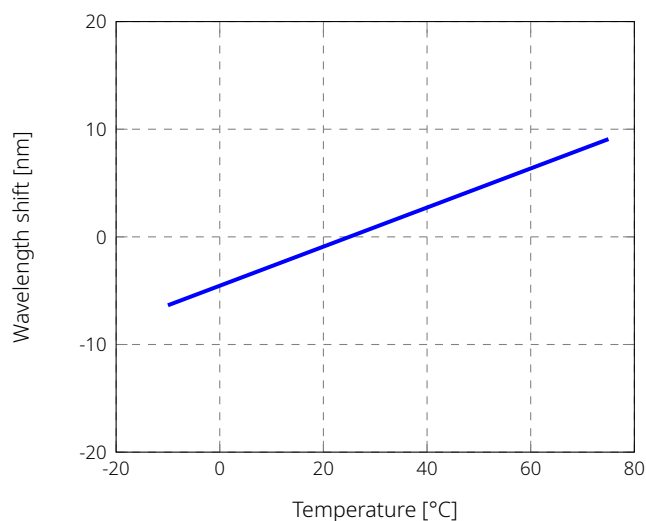

## Technical drawings

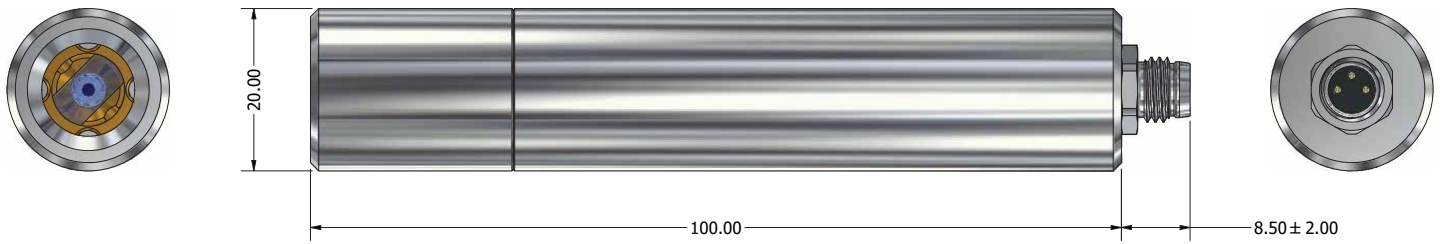

Standard variant with M8 3-pin power connector

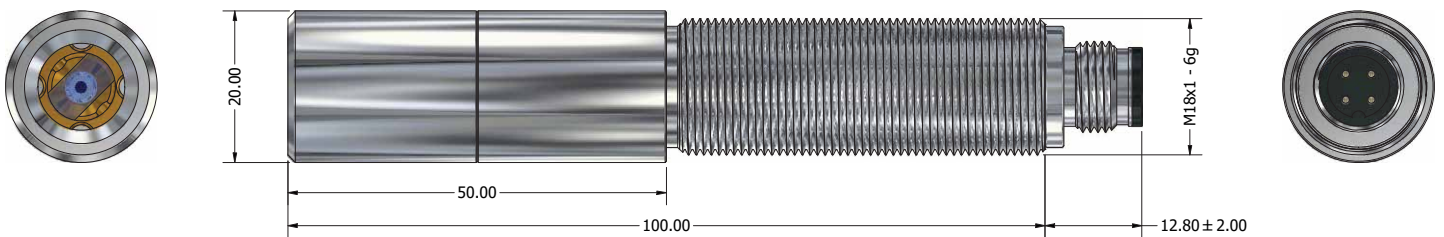

Customized -M18x1-M12/4P variant with M12 4-pin power connector and M18x1 external thread on housing

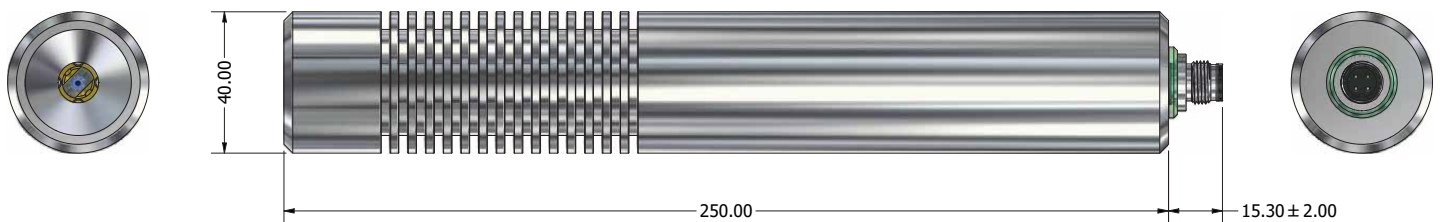

Customized enlarged LWPRO40 variant made of aluminium with extra heatsink, M12 4-pin connector and LED ring

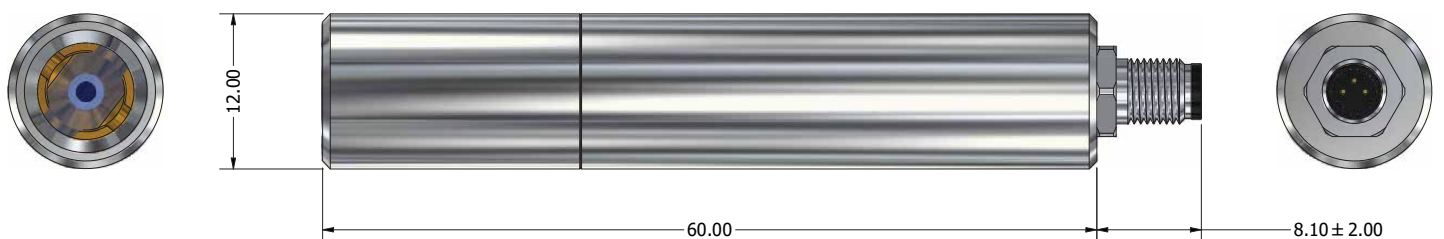

Customized miniature LWPRO12 variant made of stainless steel with M5 3-pin power connector

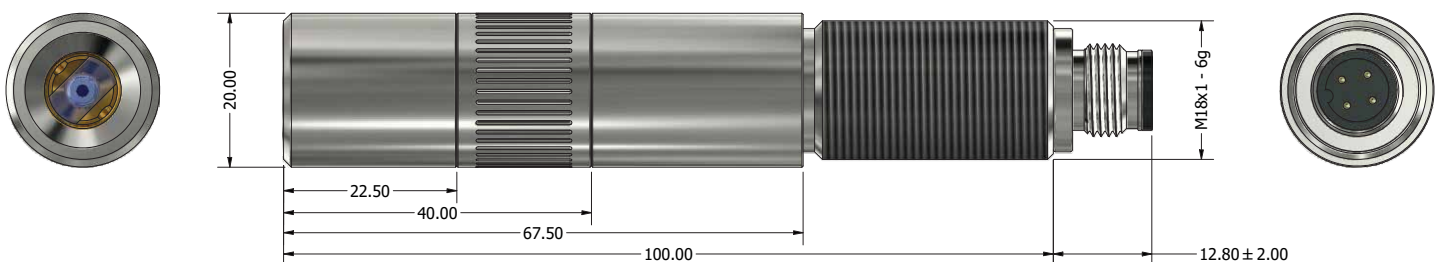

Customized externally adjustable optics LWPRO20-EA variant made of stainless steel with M12 4-pin power connector and M18x1 external thread



## Connection

This laser module uses a standard M8 3-pin connector, M5 3-pin connector or M12 4-pin connector, widely used in industry, automation and control systems. Detailed information about M8, M5 and M12 connectors is available in IEC 61076-2-104:2014.

Note that the table below shows only the pinout of laser modules in standard configuration, without any additional options. The pinout of customized lasers with -TTL, -HSAMOD, -PC420MA, -RS485, -FBPNPNO and other options is given in the section related to this additional option. Other pinouts and power connectors are available upon request. We can custom make laser modules with other power connectors, such as M9, 5.5/2.1, 5.5/2.5, IP68 cable glands and others.

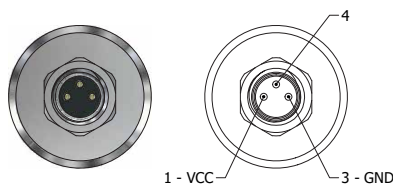

M8 3-pin power connector and M5 3-pin power connector

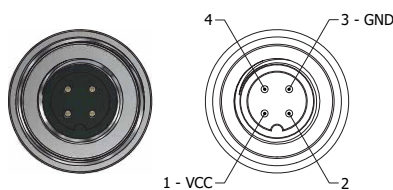

M12 4-pin power connector

Pin	Name	Cable color	Comment
1	VCC	Brown	Positive power terminal
2	—	White	M8, M5 - Pin not present M12 - Not connected
3	GND	Blue	Negative power terminal
4	—	Black	Not connected

## Customizations

LWPRO laser modules can be customized and manufactured with a wide range of additional options. The list below shows the most popular customizations, but LAMBDAWAVE is also able to make other customizations upon request. Contact us to determine feasibility, price, lead time and minimum order quantity for your specific custom solution.

### NOTE

All of the customizations described below are optional and are not present in your laser module unless you have explicitly ordered them and paid for them.

## Electronics customizations

### TTL digital modulation input

The TTL modulating input allows the laser to be turned on and off using a logic signal. The TTL input has a high input impedance and is pulled up to GND by default, which means the laser is off. The laser response is the result of an AND operation from the TTL input signal and the internal signals of the softstart, voltage protection and temperature protection. As long as the supply voltage and temperature of the laser are within the appropriate limits and the softstart time has elapsed, the TTL input allows the laser to turn on and off immediately.

### ORDER CODE

Order code: -TTL

The TTL input is a function implemented in the software

of embedded microcontroller and is not suitable for very fast modulation, such as changing the laser power by applying a PWM signal.

Fast analog modulation works only when the supply voltage and laser temperature are within the correct limits and the soft-start time has elapsed.

Pin	Name	Cable color	Comment
1	VCC	Brown	Positive power terminal
2	—	White	M8, M5 - Pin not present M12 - Not connected
3	GND	Blue	Negative power terminal
4	TTL	Black	TTL input

Pinout for -TTL variant

Parameter	Min.	Typ.	Max.	Unit
TTL input low level	-0.3	-	0.8	V
TTL input high level	2	-	V <sub>IN</sub> +0.3	V
TTL high to laser on	-	2.5	-	ms
TTL low to laser off	-	1.5	-	ms
TTL input impedance	10	-	-	kΩ

TTL input electrical characteristics

## High speed 0-5V analog modulation input

The high-speed analog modulating input allows the laser diode current to be modulated proportionally to the given 0-5V input signal at a frequency of up to 200kHz. This functionality is implemented directly in the hardware of the laser diode driver and does not take into account temperature drifts, which cause the threshold current and efficiency of the laser diode to change depending on its temperature.

### ORDER CODE

Order code: -HSAMOD

-HSAMOD  
Laser diode current vs. modulation voltage

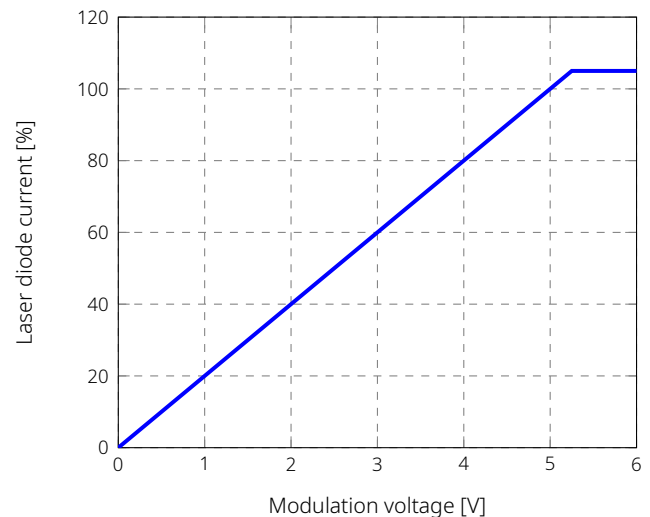

The graphs show typical characteristics of the dependence of laser diode current and laser diode power as a function of modulation voltage. Note that while the dependence of the diode current on the modulation voltage is linear, the dependence of the power on the modulation voltage is no longer linear, and in addition, the threshold current of the laser diode and its efficiency are temperature-dependent.

## -HSAMOD

Laser diode power vs. modulation voltage

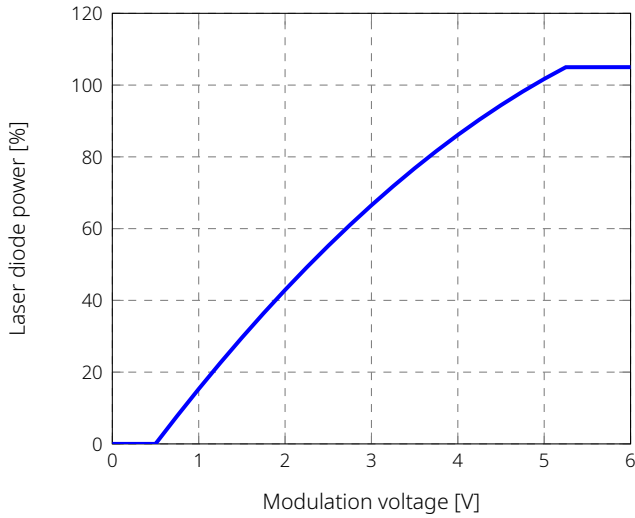

## 0-5V, 4-20mA or external resistance power control input

The power control input allows the laser power to be varied from approximately 5% to 100% using a 0-5V voltage signal, a 4-20mA current signal, or by changing the resistance of an external 10kΩ potentiometer.

### ORDER CODE

Order code 0-5V: **-PC05V**

Order code 4-20mA: **-PC420MA**

Order code external R: **-PC10K**

Pin	Name	Cable color	Comment
1	VCC	Brown	Positive power terminal
2	MOD-	White	Modulation -
3	GND	Blue	Negative power terminal
4	MOD+	Black	Modulation +

Pinout for -HSAMOD variant

Parameter	Min.	Typ.	Max.	Unit
Modulation voltage	-0.3	-	5.5	V
Modulation voltage 0-100% range	0	-	5	V
Large signal 0-5V -3dB frequency	-	200	-	kHz
Small signal -3dB frequency	-	260	-	kHz
Input impedance	10	-	-	kΩ

Fast analog modulation input electrical characteristics

## -PC05V

Laser diode power vs. control input voltage

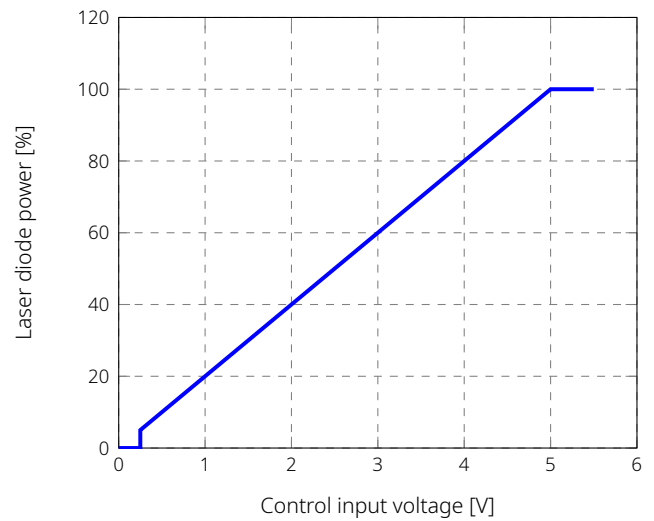

This functionality is implemented in the software of the internal microcontroller and takes into account changes in the characteristics of the laser diode depending on temperature. The refresh rate of the external signal is a maximum of 20Hz, and in any case this functionality is not suitable for modulating the laser power with any faster signal, such as PWM.

Pin	Name	Cable color	Comment
1	VCC	Brown	Positive power terminal
2	—	White	M8, M5 - Pin not present M12 - Not connected
3	GND	Blue	Negative power terminal
4	PC	Black	0-5V input

Pinout for -PC05V variant

-PC420MA

Laser diode power vs. control input current

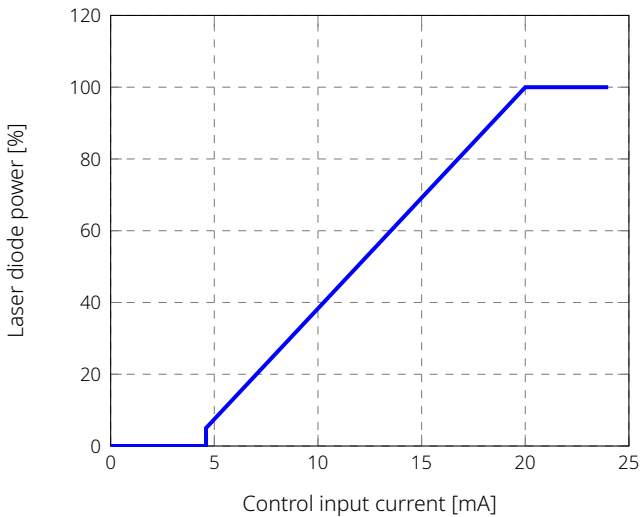

-PC10K

Laser diode power vs. external resistance

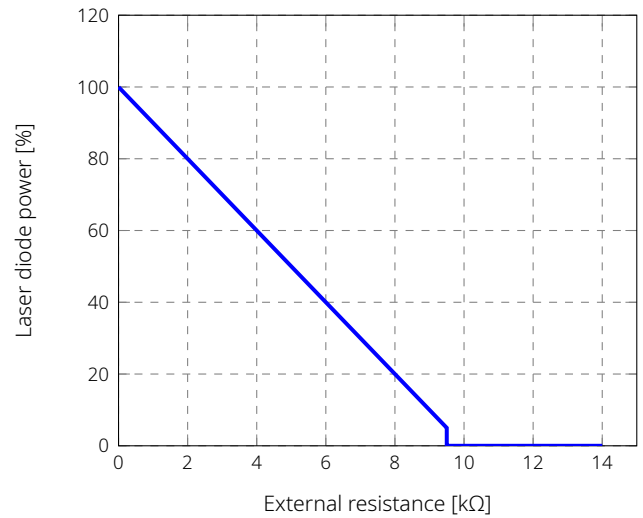

Pin	Name	Cable color	Comment
1	VCC	Brown	Positive power terminal
2	PC2	White	10kΩ resistance input
3	GND	Blue	Negative power terminal
4	PC1	Black	10kΩ resistance input

Pinout for -PC10K variant

Please note that the operation of the laser diode near its threshold current is very susceptible to temperature changes. During production, we measure the temperature-dependent characteristics of the laser diode and store the data in the Flash memory of the built-in microcontroller, but even so, the correct operation of power regulation below about 5% is not guaranteed. When a signal is applied below 5%, the diode is simply turned off.

## NPN or PNP laser diode monitor output

The laser diode monitor signal allows you to check the operating status of the laser and detect a situation where the laser diode has failed.

Pin	Name	Cable color	Comment
1	VCC	Brown	Positive power terminal
2	—	White	M8, M5 - Pin not present M12 - Not connected
3	GND	Blue	Negative power terminal
4	PC	Black	4-20mA input

Pinout for -PC420MA variant

## ORDER CODE

Order code PNP NO: **-FBPNPNO**

Order code NPN NO: **-FBNPNNNO**

Laser diodes themselves are very sensitive and vulnerable components, as they often operate at the physical limits of a given semiconductor. Despite all efforts on the part of LAMBDAWAVE and the use of multiple UVLO, OVLO, TEMP and ESD protections, there can be situations in which a laser diode fails, whether due to unexpected external factors or even spontaneously and without any reason.

Pin	Name	Cable color	Comment
1	VCC	Brown	Positive power terminal
2	—	White	M8, M5 - Pin not present M12 - Not connected
3	GND	Blue	Negative power terminal
4	FB	Black	Monitor output

Pinout for -FBPNPNO or -FBNPNNNO variant

The function of monitoring the laser diode is carried out by the software of the microcontroller embedded in the laser module, and consists of continuously checking the voltage and current of the laser diode, and, if it is possible for the laser diode, directly checking the power of the emitted light through the photodiode embedded in the laser diode. This type of checking allows us to detect all situations of damage to the diode, including catastrophic optical damage (COD) situations, in which the electrical parameters of the laser diode do not change at all, and the only symptom of damage is a drastic decrease in the amount of light emitted.

Parameter	Min.	Typ.	Max.	Unit
Monitor sample rate	-	1	-	ksps
Output current	-	-	10	mA
Voltage drop at 10mA	-	-	1.5	V

Monitor output electrical characteristics

## RS485 communication

Communication in the RS485 standard allows you to control the operation of the laser and read its operating parameters, in particular:

- Setting the laser address for communication
- Control of switching the laser on and off
- Controlling the power of the laser
- Reading of the laser temperature
- Reading the supply voltage
- Reading the voltage and current of the laser diode
- Direct reading of laser power based on built-in photodiode
- Total operating time readout
- Readout of maximum recorded operating parameters

## ORDER CODE

Order code: **-RS485**

LAMBDAWAVE laser modules can be assigned a unique communication address and up to 255 devices can be independently controlled on a single RS485 line. Standard communication parameters are 9600 8N1 and RS485 line terminators disabled. On request, the communication parameters can be set to different, and in addition, the laser can be equipped with internal 120Ω line terminators, both

DC and AC.

Pin	Name	Cable color	Comment
1	VCC	Brown	Positive power terminal
2	B/D+	White	RS485 B/D+ signal
3	GND	Blue	Negative power terminal
4	A/D-	Black	RS485 A/D- signal

Pinout for -RS485 variant

[↓ PDF drawing](#) [↓ 3D STEP model](#)

## Miniature size $\phi 12\text{mm} * 60\text{mm}$ housing

LWPRO laser modules can be manufactured in miniature stainless steel housings with a diameter of 12mm and a length of 60mm. The power connector in this case is M5 3-pin. Due to the small size of the housing and the limitation in heat dissipation, it is not possible to make high-power lasers in such a housing.

## Hardware customizations

### Housing with external M18x1 thread

LWPRO laser modules can be made in a standard stainless steel housing with a diameter of 20mm and a length of 100mm, but with an additional external thread of M18x1. Available with M12 4-pin and M8 3-pin power connectors. In this variant, two M18x1 stainless steel nuts are added together with the laser.

#### ORDER CODE

Order code M12 4-pin: **-M18x1-M12/4P**

Order code M8 3-pin: **-M18x1-M8/3P**

#### ORDER CODE

Order code: **LWPRO12-**



[↓ PDF drawing](#) [↓ 3D STEP model](#)

## Enlarged size $\phi 40\text{mm} * 250\text{mm}$ housing with heatsink

LWPRO laser modules can be made in enlarged 40mm diameter, 250mm long housings, made of aircraft-grade aluminum and with additional fins for better heat dissipation. The power connector in this case is M12 4-pin, and an



# LWPRO-675-1

Professional 675nm red IP67 waterproof 1mW laser module

optional LED-illuminated ring is available to indicate operating status of the laser. Thanks to excellent heat dissipation, very high-power lasers are possible in this housing variant.

## ORDER CODE

Order code natural color: LWPRO40-

Order code black color: LWPRO40-BL-



[PDF drawing](#) [3D STEP model](#)



[PDF drawing](#) [3D STEP model](#)

## Externally adjustable optics

LWPRO laser modules can be equipped with an external laser beam focusing ring for ultra-precise adjustment of spot size or line thickness. Such lasers are made in a stainless steel housing with a diameter of 20mm and a length of 100mm and with an additional external thread M18x1. Available with only M12 4-pin power connectors. In this variant, two M18x1 stainless steel nuts are added along with the laser.

## ORDER CODE

Order code: LWPRO20-EA-

## Accessories

### FLAT-TILT-LASER20 bracket

20mm laser module holder, mounted to flat surface, with tilt joint. Made of aluminium, black anodized surface.

#### ORDER CODE

Order code: FLAT-TILT-LASER20

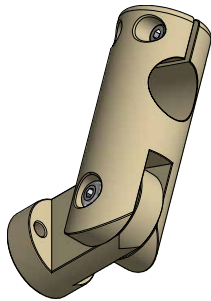

[↓ PDF drawing](#) [↓ 3D STEP model](#)

### FLAT-TILT-ROT-LASER20 bracket

20mm laser module holder, mounted to flat surface, with tilt joint and rotary joint. Made of aluminium, black anodized surface.

#### ORDER CODE

Order code: FLAT-TILT-ROT-LASER20

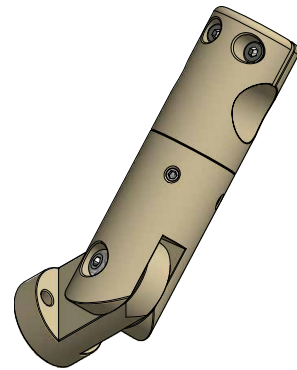

[↓ PDF drawing](#) [↓ 3D STEP model](#)

### ROD12-LASER20 bracket

20mm laser module holder, mounted on a 12mm rod. Made of aluminium, black anodized surface.

#### ORDER CODE

Order code: ROD12-LASER20

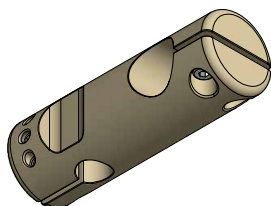

[↓ PDF drawing](#) [↓ 3D STEP model](#)

### ROD12-ROT-LASER20 bracket

20mm laser module holder, mounted on a 12mm rod, with rotary joint. Made of aluminium, black anodized surface.

#### ORDER CODE

Order code: ROD12-ROT-LASER20

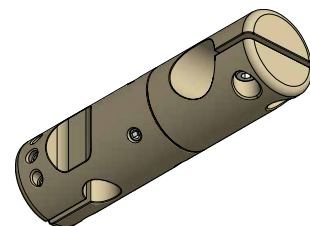

[↓ PDF drawing](#) [↓ 3D STEP model](#)



## LW-MNT-STB-20 bracket

20mm laser module holder, mounted to flat surface, with tilt joint and sliding adjustment. Made of steel, painted in black.

### ORDER CODE

Order code: LW-MNT-STB-20

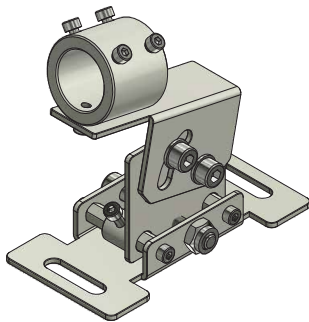

[↓ PDF drawing](#) [↓ 3D STEP model](#)

## Power supply cables

M8, M5 or M12 power cables in lengths from 2m to 20m.

### ORDER CODE

Order code M8 3-pin 2m: M8-3P-FS-2M-PUR

Order code M8 3-pin 5m: M8-3P-FS-5M-PUR

Order code M8 3-pin 10m: M8-3P-FS-10M-PUR

Order code M8 3-pin 20m: M8-3P-FS-20M-PUR

Order code M5 3-pin 2m: M5-3P-FS-2M-PUR

Order code M5 3-pin 5m: M5-3P-FS-5M-PUR

Order code M12 4-pin 2m: M12-4P-FS-2M-PVC

Order code M12 4-pin 5m: M12-4P-FS-5M-PUR



## Safety

This laser module emits highly concentrated visible or invisible light, which can be extremely hazardous to human eye or body, causing irreparable damage. Do not expose eyes or skin to any laser light directly or through optical lenses. Wear appropriate safety glasses when operating laser equipment to prevent laser light from entering the eye. Never look into the beam directly or through optical instruments. Take extra precautions when using the laser module indoors, paying attention to any reflective surfaces. Never point the laser beam at people, animals, vehicles or airplanes.

### WARNING

This laser device is an electronic component designed solely for incorporation or integration into a final device. The final device incorporating this laser component must comply with the safety rules described in IEC 60825-1 or other applicable standard.

#### IEC 60825-1 - Safety of laser products:

*Laser products that are sold to other manufacturers for use as components of any system for subsequent sale are not subject to IEC 60825-1, since the final product will itself be subject to this standard. Laser products that are sold by or for manufacturers of end products for use as repair parts for the end products are also not subject to IEC 60825-1.*

Final devices incorporating LAMBDAAWAVE laser modules must comply with the safety standards described in IEC 60825-1 or other applicable equivalent standard. The manner in which LAMBDAAWAVE laser modules are used in an end product may change their original safety classifica-

tion, therefore it is absolutely necessary to perform all required safety measurements for devices into which LAMBDAAWAVE products are incorporated or integrated. Ensuring that the final device complies with the relevant standards rests solely with its integrator.

### NOTE

LAMBDAAWAVE laser modules are electronic components intended only for incorporation or integration into final devices, and therefore are not subject to IEC 60825-1 and are not certified according to IEC 60825-1 by default, unless clearly and explicitly written.

Some of LAMBDAAWAVE laser modules can already be tested and certified by LAMBDAAWAVE in accordance with IEC 60825-1. This includes some low- and medium-power lasers with high-divergence optics for which Class 1, 1M, 2, 2M or 3R is used. In that case, it is clearly and explicitly written in the documentation and applies only to exactly that, precisely and unambiguously specified, model of laser with exactly that output optics.

Note also that even if a laser module is classified in a low and safe safety class, it may internally contain a high-power laser diode. The low safety class may be mainly due to the fact that the particular laser is equipped with optics with a very wide angle of light. It is absolutely forbidden to use the laser in case of any damage to the optics, both in case of damage visible to the naked eye, as well as in case of suspected damage to the optics manifesting itself in the abnormal way the laser shines.

## Information about WEEE

This component is a subassembly intended for integration or incorporation into a final device only by a professional. This component itself is in no way a final device, and in particular is not a household appliance. The person integrating the end device should take into account that it contains an electronic component and must not be disposed of with ordinary household waste. Separate disposal methods should be used for used electrical and electronic equipment.

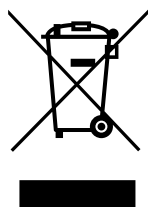

We would also like to remind you that if, contrary to the above statement, in the unlikely and unpredictable event that this component is used on its own as a final device, it is still an electronic component and must not be disposed of with normal municipal waste. Separate disposal methods should be used for used electrical and electronic equipment. The user who intends to dispose of used electrical and electronic equipment is obliged to take it to a collection point for used equipment.

You can also return the product directly to us. We will be happy to professionally disassemble it and reuse all those parts that are fully operational and show no signs of wear. In this way, we will drastically reduce the number of new components needed for the production of subsequent batches of lasers. Otherwise, components such as optics or metal housings, for example, would have to be manufactured again from scratch and with unnecessary use of further natural resources.

## Disclaimer

The above specifications of the product are for reference purpose only and may be modified for improvement without prior notice.

Every possible effort has been made to ensure that the information described in this specification is fully accurate. However, LAMBDAAWAVE is not liable for any damage resulting from inaccuracies in these specifications. The data, charts and all other information described in these materials were correct at the time this specification was issued.

LAMBDAAWAVE constantly strives to increase the level of its products quality and reliability. Despite these efforts, there may be situations where our products suffer from failures or other problems. Design your product so that LAMBDAAWAVE products are used in the operating ranges described above. Foreseeable failures or emergency modes should be considered in designed equipment to ensure that devices containing LAMBDAAWAVE products do not cause injury, fire or other damage. Extensive assessments of each individual system as a whole should be made, with the customer taking full responsibility for design decisions and possible damage caused by the system. LAMBDAAWAVE is not responsible for any defects or injuries that may be caused by the equipment using LAMBDAAWAVE devices.

LAMBDAAWAVE prohibits the buyer from reverse engineering, disassembling or taking other steps to obtain a product design.

Products described in these specifications have been designed and manufactured for use in general electronics. Please consult LAMBDAAWAVE when considering using the products described in these specifications in any critical system requiring high reliability, including aviation, military, nuclear, automotive or life support systems.

# LWPRO-675-1

Professional 675nm red IP67 waterproof 1mW laser module

The latest version of this datasheet is available at the address given below.

[https://www.lambdawave.eu/datasheets/  
LWPRO-675-1.pdf](https://www.lambdawave.eu/datasheets/LWPRO-675-1.pdf)

## About LAMBDAWAVE

LAMBDAWAVE laser technology is a Polish manufacturer of laser equipment. Our goal is to allow easy use of laser technology in your products. We offer various laser solutions dedicated for use in science, industry and entertain-

ment. Thanks to our experience in the field of electronics, optics and embedded software, we are able to meet your requirements by providing reliable and tailor-made laser solutions for your business. Our portfolio includes but is not limited to laser modules in a wide range of powers and wavelengths, laser pointers and various laser power supplies. For more information, please visit our website or write us an e-mail.

<https://www.lambdawave.eu>  
[info@lambdawave.eu](mailto:info@lambdawave.eu)

# LWPRO-675-1

Professional 675nm red IP67 waterproof 1mW laser module

## Product photos

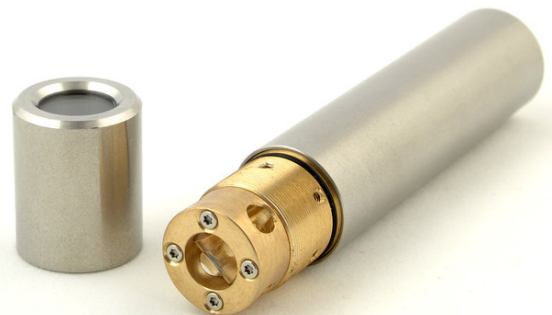

Power cables, brackets, power supplies and all other accessories shown in the photos are sold separately.